



Peplink for Managed Service Providers (MSPs)

About Peplink



**Peplink makes
connectivity always reliable.**

Peplink's SpeedFusion enterprise branch and cellular routers have been deployed around the world, helping thousands of customers from various industries to increase bandwidth, enhance internet reliability, and reduce costs. Our complete product line includes models for businesses of all sizes and provides a seamlessly mobile and reliable internet experience for customers anywhere.

Challenges in MSP Connectivity



MSPs often have to put together multiple vendors for a complete solution which will require **more management and integration** from MSPs.



MSPs that operate within thin margins have **limited services to offer clients**, while enterprise workload is evolving to include mobile and remote places.

What Peplink offers MSPs

- + Connection to multiple WAN technologies
- + Multi-carrier support
- + Network enhancing technologies for improved performance and redundancy
- + Remote configuration and management via a centralized platform
- + OOBM-alternative software to remotely connect to devices on the LAN
- + Enterprise-grade and affordable solutions
- + Scalable and flexible options to align with client requirements

Peplink's MSP Connectivity Solution



VIEW

MSPs have full control and supervision over FusionHub and InControl

Set up multiple connections simultaneously for MSP-hosted SpeedFusion Cloud servers

Mix & match SIM resources

FUSIONSIM

FusionHub

InControl²

Customize MSP-branded cloud management and use InTouch for remote access and out-of-band management (OOBM)

- Improve the SLA of cellular WAN
- Protect applications like VoIP and video calls
- Safeguard SaaS applications and VPN sessions

SpeedFusion Connect LTE

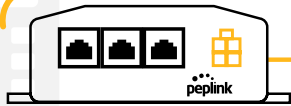

BR1 Mini



BR1 Pro 5G

Balance 20X



MSP-Friendly Business Model

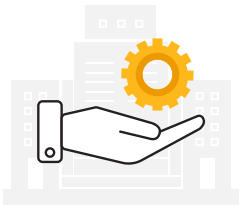

Managed Service Provider



Robust Devices

Quality products with robust software and housed in ruggedized hardware at unbeatable prices



MSP-Friendly License Model

MSP-friendly license model with fairly priced subscription and no device lock-in after subscription expires



CarePlans

Simple Billing

Offer one price to cover multiple years of management using a synchronized annual CarePlans billing cycle



SpeedFusion Connect LTE

Leverage on-demand 5G/LTE data from multiple carriers and offer it as a white-label service to clients



End Users



VIEW



Cloud-Based Endpoint Management System

- Aggregate data to generate useful reports
- Push configurations to any and all endpoints
- Save on configuration time and truck rolls while staying on top of network status



On-Premise Control

- InControl Virtual Appliance (ICVA) for on-premise management platform for complete control
- Can be hosted on any private network for full ownership over sensitive data and to minimize any chance of attack



Custom Central Management

- MSP-branded cloud management for a more personalized platform
- MSP-friendly license model, retaining access even after subscription expiration



InControl Services

- Access all remote devices behind a router with just one login
- Integrates each remote device's platform onto InControl for seamless connectivity and simpler management



InControl Key Features

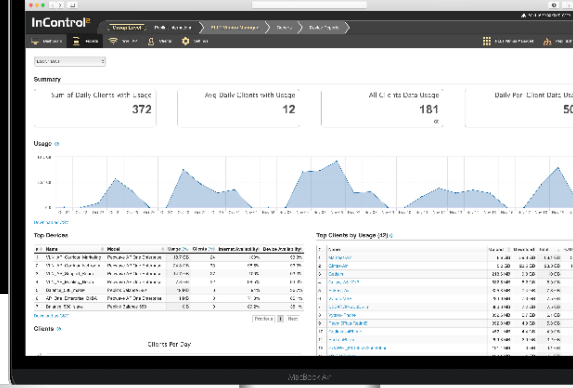

Device Management

- IP Settings
- System Management

Reports

- Device Reports
- Wi-Fi Reports
- Usage Reports
- SIM Card Reports
- Event Logs
- Tags

Captive Portal

- Captive Portal Reports

Centralized Bulk Configuration

PepVPN / SpeedFusion

- Live Monitoring
- Configuration

Wi-Fi AP

- Group-Wide SSID Settings
- Group-Wide Remote Settings

Network Settings

- Outbound Policy
- Firewall Rules
- Grouped Networks
- Access Control List
- VLAN Networks
- LAN Networks
- Route Advertisement

Device Schedule Management

API Integration

Geo-Fencing



InTouch Services

VIEW



- Peplink's alternative to out-of-band management (OOBM) and remote access
- Integrates all device interfaces onto a single platform
- One login to access all remote devices behind the router

IP devices

Remote devices

Programmable logic controllers (PLCs)

Remote protocols for servers

And more



Requirements

- Active InControl License
- SpeedFusion Connect Plan
- Devices running Firmware 8.2.0 and above



Configure Anything, Anywhere

InTouch is an easy way to reach any device that you need to view, configure, or troubleshoot remotely



No Setup Required

InTouch eliminates the need for engineers, VPNs, servers, or extra software typically needed to manage your devices



No Security Compromises

InTouch never requires public IPs, inbound access through firewalls, or any other security compromises to get your job done

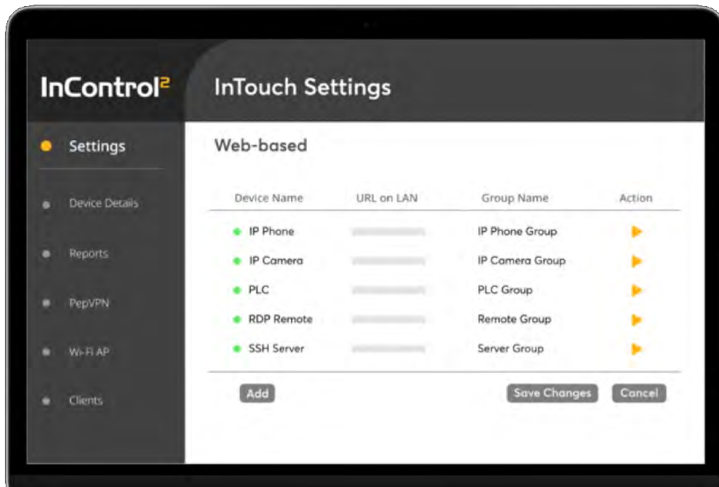

Other Tools for MSPs

On-Demand 5G/LTE Data

- Leverage multiple networks under a single plan
- Access 5G/LTE data along with SpeedFusion Connect



VIEW



Multi-Year Multi-Device Pool Plans

- Simplify data plan management with 5G and LTE offerings for multiple devices for multiple years
- Eliminate need for multiple contracts while retaining access to multiple carriers



Mix & Match SIMs for Custom Plans

- Flexibly mix and match SIM resources to offer highly customized, reliable, and unthrottled plans to clients
- Store SIMs from multiple carriers at the SIM Injector to ensure clients get the best coverage and reduce failover costs



Manage SIMs Remotely

- Access SIM cards outside of routers' integrated SIM slots
- Remotely address challenges within the network of large deployments
- Reduce truck rolls and site surveys



SFC SIM Nodes for MSP

- Build your own managed services with FusionSIM technology
- Capable of hosting a SpeedFusion Cloud node and act as a FusionSIM platform

Application: Retail PoS System



VIEW



The **MAX BR1 Mini** combines value and resiliency with SpeedFusion's **Hot Failover to ensure online connectivity** and Wi-Fi for retail stores' PoS systems. Securely housed in a sleek and ruggedized enclosure makes this device conveniently deployable.

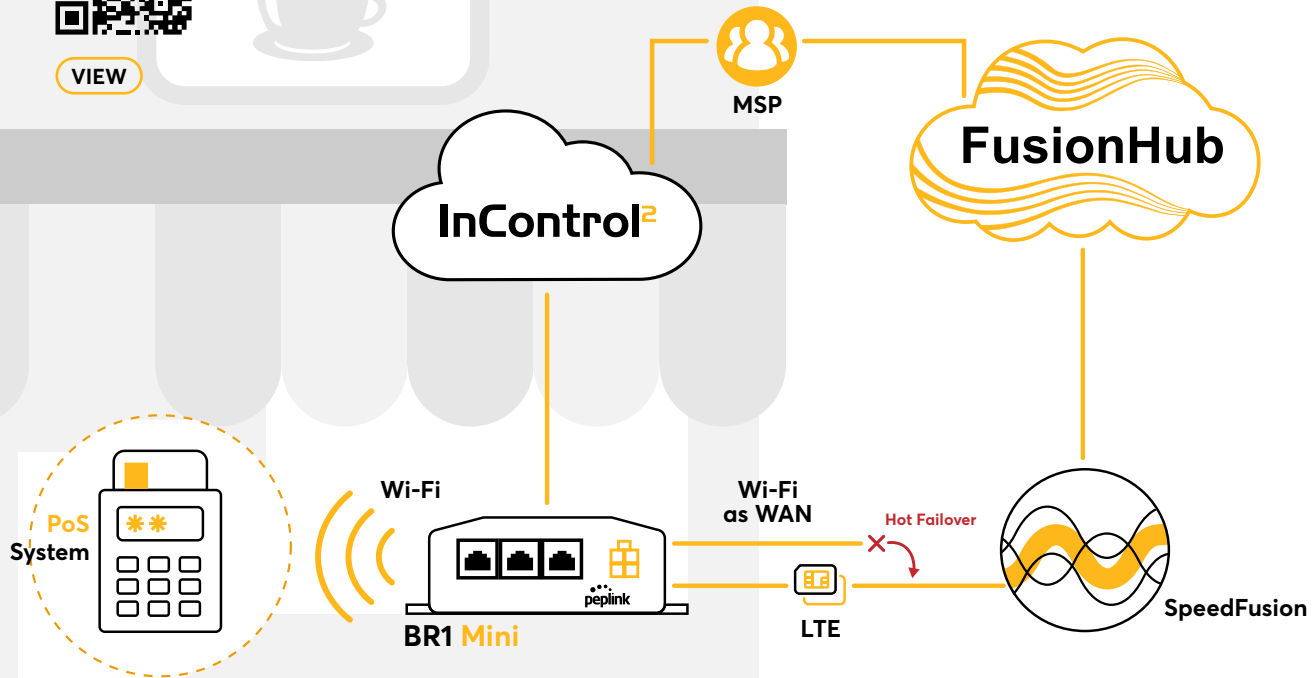



DATASHEET



BR1 Mini

Durable With an Unbeatable Price Performance

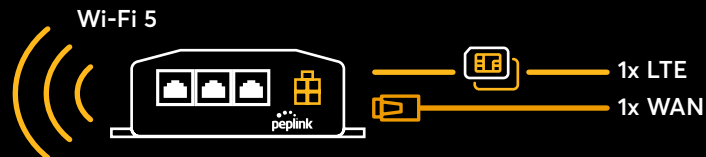

Versatile with Wi-Fi WAN



One-Device Connectivity Solution



Plug-and-Play Functionality

The BR1 Mini, with its durable form factor, is built to withstand challenging deployment scenarios. The device's Micro-Fit industrial connector also makes it a versatile device for many deployment possibilities.

The BR1 Mini's plug-and-play capability also makes it an excellent device for remote configuration.

Application: VoIP



VIEW



The **Balance 20X** futureproofs office connectivity with its versatile FlexModule Mini slot that accepts all kinds of WAN technology. Paired together with a FusionHub, **WAN Smoothing fills connectivity gaps to ensure minimal latency and packet loss.** This means never missing a frame or sentence in conference calls or VoIP applications.

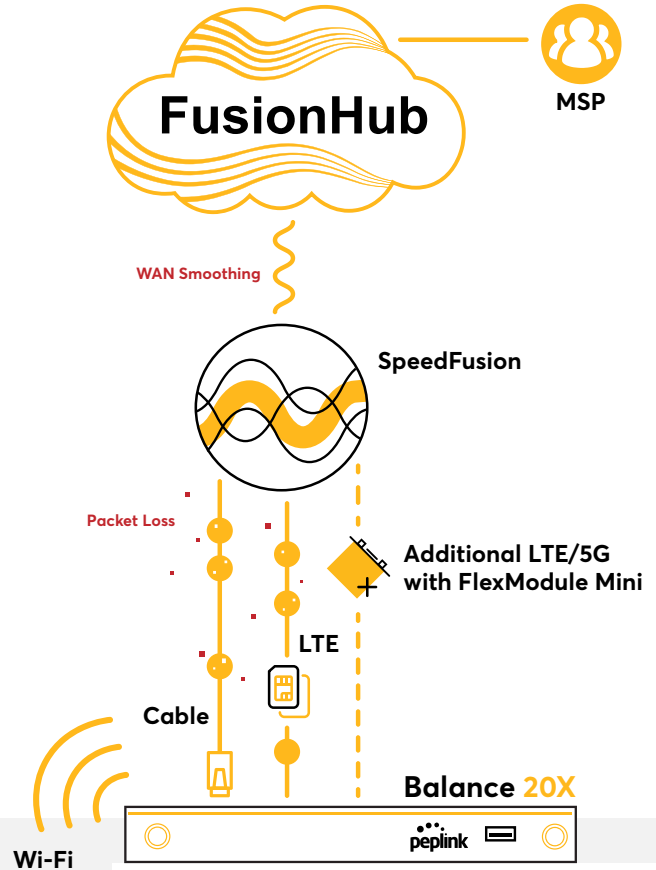



DATASHEET

Balance 20X

Futureproof SD-WAN Router for Small Businesses and Branches



Wi-Fi 5



1x LTE

1x WAN



Expandable Modules



Optional Second Cellular Radio



Enterprise-Grade Security and Management

The Balance 20X delivers excellent routing throughput and Wi-Fi capabilities, while featuring an embedded cellular modem that backs up the xDSL. The FlexModule Mini slot welcomes another LTE-A module, a 5G module, and a VDSL module. The Balance 20X is the go-to device for VoIP applications for its groundbreaking price-performance.

Application: Vehicle Networking



VIEW

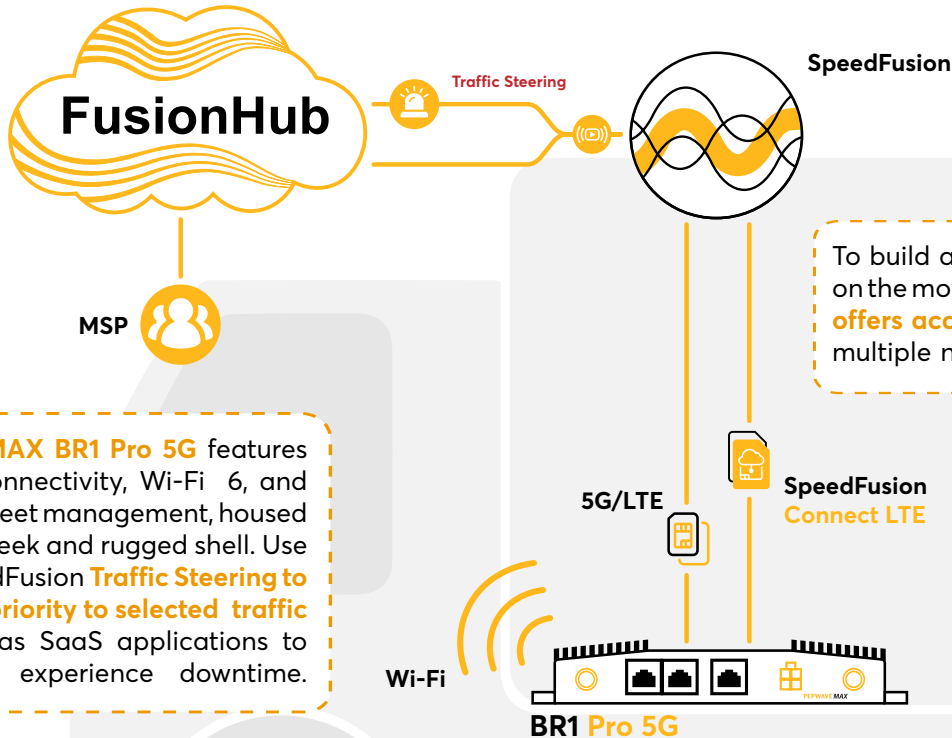



DATASHEET

BR1 Pro 5G

| The Classic Goes Sonic

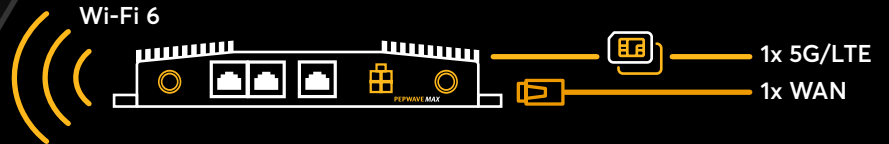

GPS Fleet Management



Ignition Sensing



Slim and Low-Profile Form Factor

Its new generation multi-core CPU enables gigabit speeds and the use of applications simultaneously without compromise. The built in GPS fleet tracking transmits any vehicle's location and route data in real time. The device's low-profile form factor and high operating temperature range makes deploying the BR1 Pro 5G worryless in compact and heated spaces.

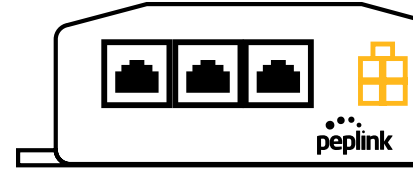
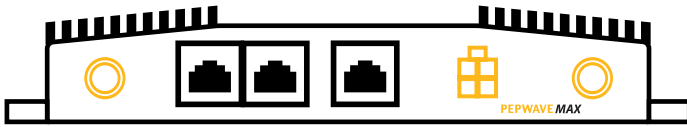

Follow us on



[company/Peplink](#)



[Peplink](#)



[PeplinkChannel](#)



[@Peplink](#)



[Peplink](#)

[peplink.com](#)

